



INSTITUTO ELECTORAL DEL
ESTADO DE CAMPECHE

MATERIAL ELECTORAL



**PROCESO ELECTORAL
ESTATAL ORDINARIO
2014-2015**

ELECCIONES 2015

MATERIAL ELECTORAL.

1. Cancel electoral (modelos A y B).
2. Urna de Gobernador.
3. Urna de Diputados Locales.
4. Urna de Ayuntamientos.
5. Urna de Juntas Municipales.
6. Paquete electoral de Gobernador.
7. Paquete electoral de Diputados Locales.
8. Paquete electoral de Ayuntamientos.
9. Paquete electoral de Juntas Municipales.
10. Cinta de Seguridad IEEC.
11. Base porta urna.
12. Caja contenedora de material electoral para tres y cuatro elecciones (modelos A y B).

1. CANCEL ELECTORAL MODELO A

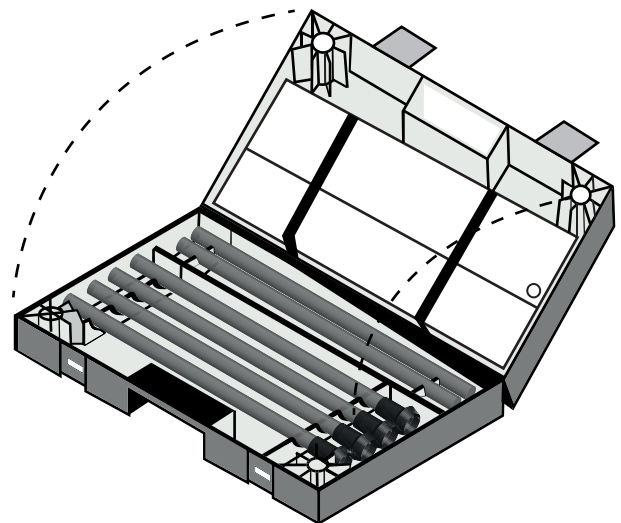
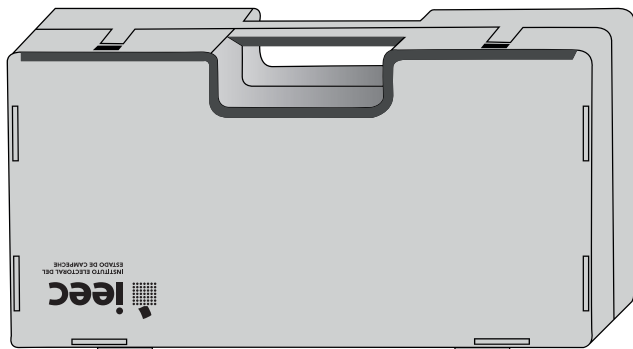
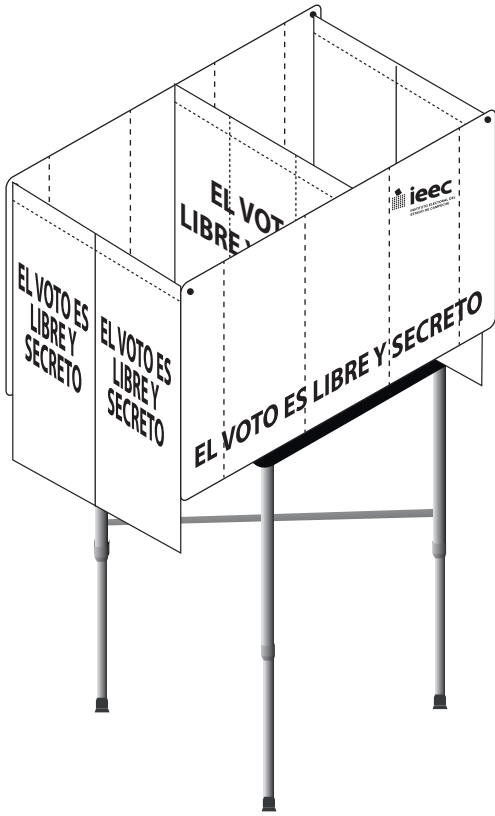

1. CANCEL ELECTORAL MODELO B

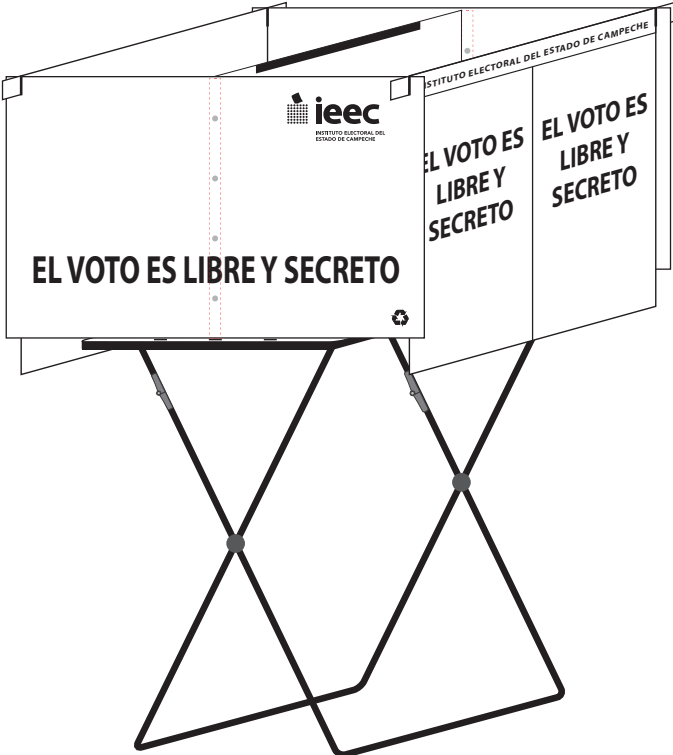
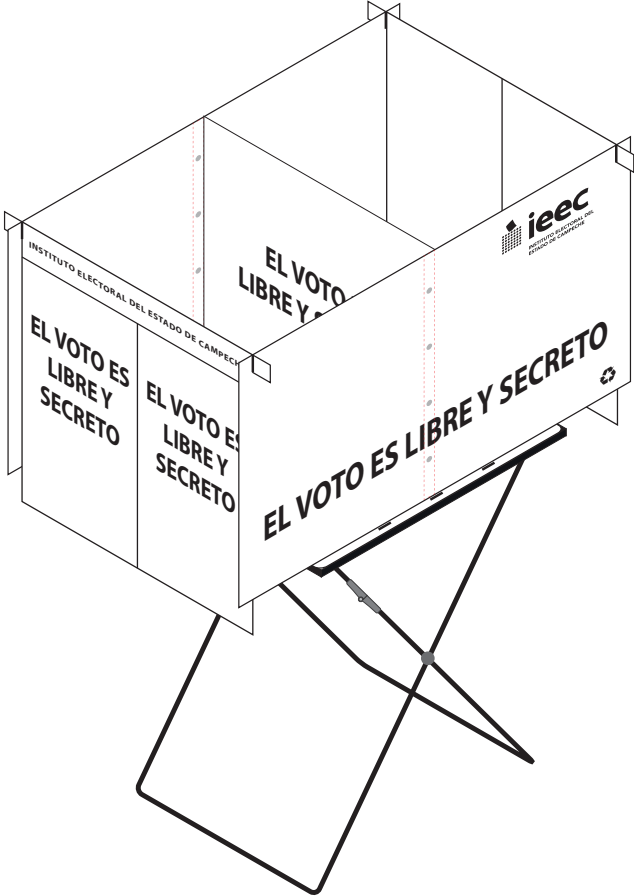

2. URNA DE GOBERNADOR.

CARA SUPERIOR



CARA FRONTAL



CARA INFERIOR

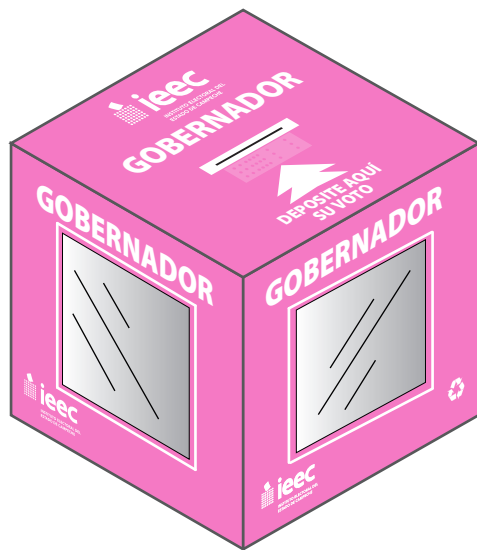
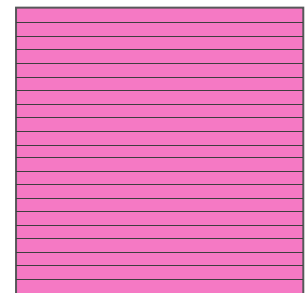

PLEGADO



3. URNA DE DIPUTADOS LOCALES.

CARA SUPERIOR



CARA FRONTAL



CARA INFERIOR

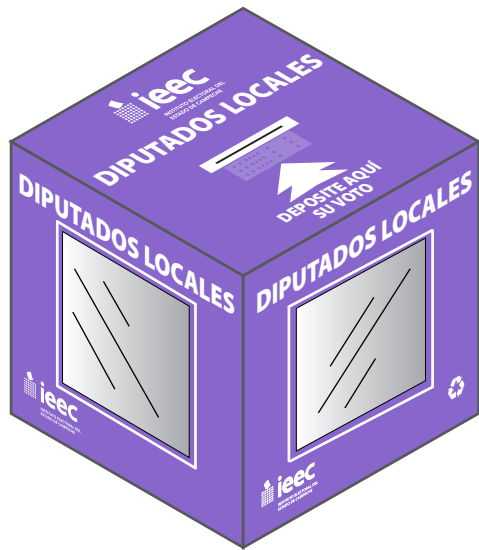
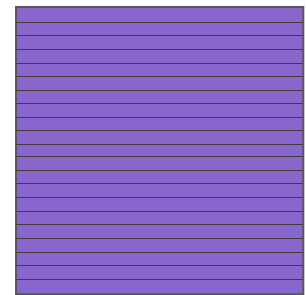

PLEGADO



4. URNA DE AYUNTAMIENTOS.

CARA SUPERIOR



CARA FRONTAL



CARA INFERIOR

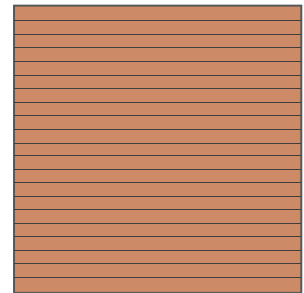

PLEGADO

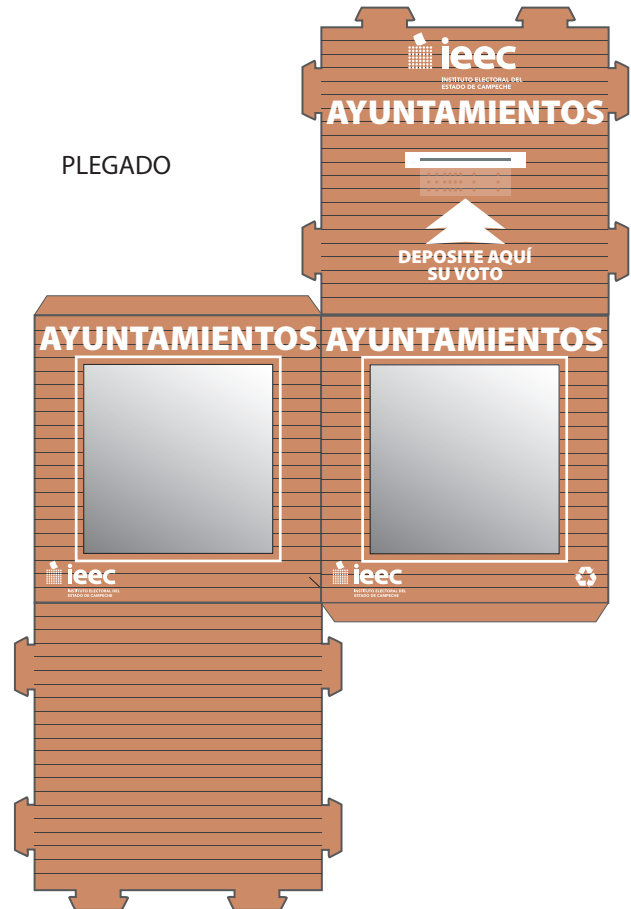

5 URNA DE JUNTAS MUNICIPALES.

CARA SUPERIOR



CARA FRONTAL



CARA INFERIOR

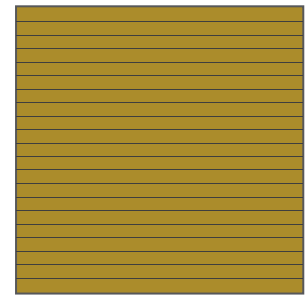

PLEGADO



6. PAQUETE ELECTORAL DE GOBERNADOR.



7. PAQUETE ELECTORAL DE DIPUTADOS LOCALES.



8. PAQUETE ELECTORAL DE AYUNTAMIENTOS.



9. PAQUETE ELECTORAL DE JUNTAS MUNICIPALES.



10. CINTA DE SEGURIDAD IEEC.



11. BASE PORTA URNA.

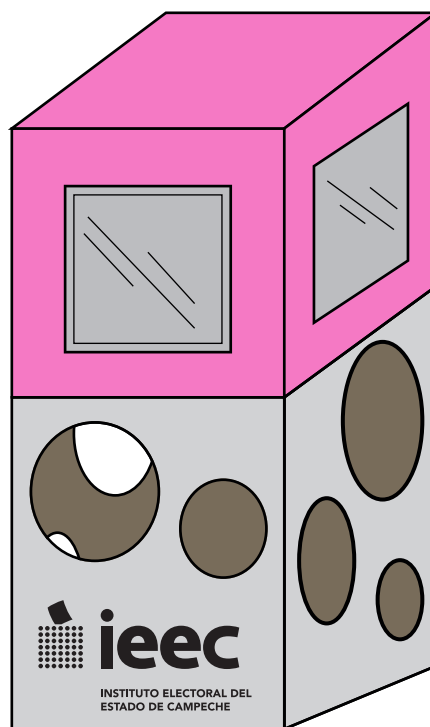
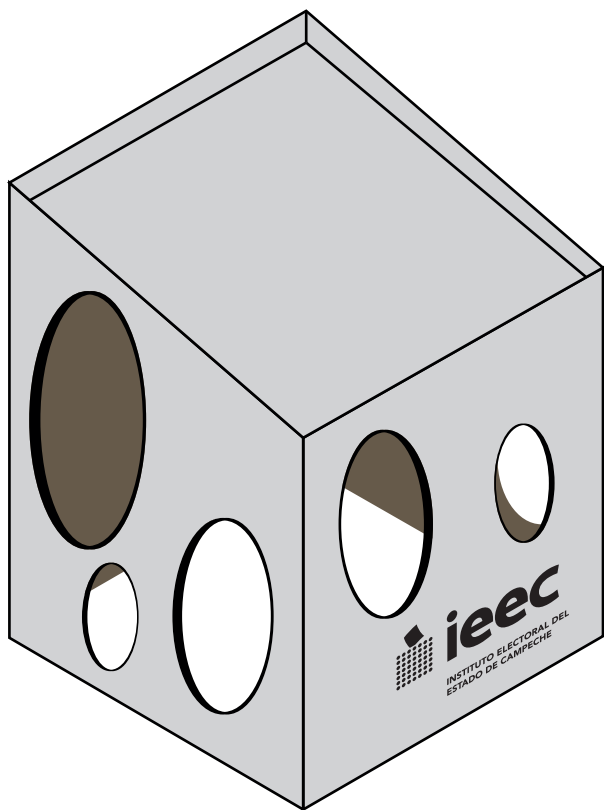

12. CAJA CONTENEDORA DE MATERIAL ELECTORAL PARA TRES Y CUATRO ELECCIONES MODELO A Y B.

